

MDrive® AccuStep 23 Step • Torque • Speed



IMS
INTELLIGENT MOTION
SYSTEMS, INC.

Schneider
Electric

Specifications

Electrical Specifications	
Input Voltage (+V) Range*	+12 to +60 VDC
Max Power Supply Current (Per MDrive)*	2 A
*Actual Power Supply Current will depend on voltage and load.	
Environmental Specifications	
Operating Temperature (non-condensing)	Heat Sink: -40°C to +85°C Motor: -40°C to +100°C
I/O Specifications	
Motion, Direction and Enable	
Voltage Range (Sinking or Sourcing)	+5 to +24 VDC
Current (+5V Max)	8.7 mA
Current (+24V Max)	14.6 mA
Attention Output	
Collector-Emitter Voltage	60 VDC
Emitter-Collector Voltage	7 VDC
Output Current	5.5 - 42 mA
Analog Input	
Range	0 to +5 V, 0 to +10 V, -10 to +10 V
Motion Specifications	
Digital Filter Range	50 nS to 12.9 μS (10 MHz to 38.8 kHz)
Clock Types	Step/Direction, Up/Down, Quadrature
Step Frequency (Max)	5 MHz
Step Frequency Minimum Pulse Width	100 nS
Number of Microstep Resolution Settings	20

Available Microsteps Per Revolution									
200	400	800	1000	1600	2000	3200	5000	6400	10000
12800	20000	25000	25600	40000	50000	51200	36000 ¹	21600 ²	25400 ³
1=0.01 deg/μstep 2=1 arc minute/μstep 3=0.001 mm/μstep									

Notes and Warnings

Installation, configuration and maintenance must be carried out by qualified technicians only. You must have detailed information to be able to carry out this work. This information can be found in the user manual.

- Unexpected dangers may be encountered when working with this product!
- Incorrect use may destroy this product and connected components!

The user manual is not included, but may be obtained from the Internet at: <http://www.imshome.com/downloads/manuals.html>.

Required for Setup*

- PC running Microsoft® Windows XP Service Pack 2 or greater.
- AccuStep Configurator GUI (available online).
- +12 to +60 VDC unregulated linear or switching power supply.
- 0 to 5 MHz Clock signal for step clock, may be a controller high speed output or signal generator (step mode operation).
- SPST switch or controller I/O point to control axis direction.
- SPI communications interface (recommended: MD-CC402-001 communication converter).

You may also need:

- I/O and Power interface to 12-pin wire crimp connector (recommended: PD12-1434-FL3 prototype development cable).

* If you purchased your MDrive with a QuickStart Kit, you have received all of the connecting cables needed for initial functional setup and system testing.

Getting Started

All documentation, software and resources are available online at: http://www.imshome.com/products/mdrive_motor_driver.html.

Use of the manual is required to understand parameter settings.

Connecting Power and I/O

Your MDrive AccuStep is configured with power and I/O combined on a single connector. Please refer to the opposite side of this document for connecting details and available connectivity options including prototype development cables and recommendations.

Connecting Communications

1. Connect USB to SPI communications converter to MDrive and PC.
2. Install the communication converter drivers onto PC (available online).

Installing the AccuStep GUI and initial setup

1. Connect RS-422/485 communications converter to MDrive and PC.
2. Install the communication converter drivers onto PC (available online).
3. Install and open the AccuStep GUI.
4. Apply power to MDrive.
5. Connect to the appropriate port.
6. Within the "Select Application" area, select the radio button for the desired mode of operation, step, torque, speed or velocity (shown below). Configure parameters as required by your application.



Setup Parameters

Operating Mode (Select Application)	Select: Step & Direction (ASM), Torque Control (AST), Speed Control (ASO) or Velocity (ASV).	
AccuStep Settings	Setup/Configuration	Turn AccuStep off or on in fixed or variable mode; set and confirm encoder line count.
	Operation	Set control bounds for motor torque and speed, lead, lag, and make-up of lost steps.
	AccuStep Status	Display status alerts of 8 pre-programmed fields, read-only.
	Calibration	To maintain synchronization, select options for motor's rotor-to-stator physical position.
Analog Settings	Set analog ranges, select input mode: 0-5V, 0-10V, -10 to +10V (not applicable for Step/Direction mode).	
Communication Settings	Set baud rate; enable/disable parity mode and features; Check Sum integrity quality assurance.	
I/O Settings	Clock and filter settings; Attention output with 11 pre-programmed fields to select among.	
Motion Settings	All operating modes	Set various motion settings, which vary with the operating mode selected ex. Current, MSEL.
	Speed control mode	Additional settings: for setting acceleration, deceleration, velocity and flags.
Defaults	Restore system defaults or previously stored settings; view current communication settings.	

Mechanical Specifications

NOTE: For linear actuator products, see manual for screw specifications

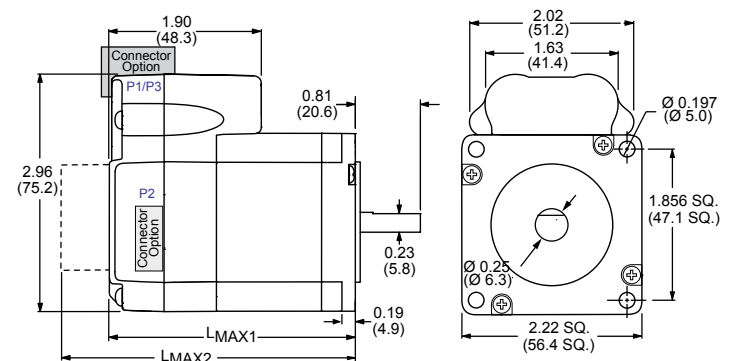

Motor Length	Dimensions in inches (mm)	
	LMAX (Single Shaft or Internal Encoder)	LMAX2 (Control Knob)
Single	2.65 (67.31)	3.36 (85.34)
Double	3.02 (76.71)	3.73 (94.74)
Triple	3.88 (98.55)	4.59 (116.59)
Quad	5.28 (135.15)	5.99 (152.19)

MDrive AccuStep 23 Step • Torque • Speed Connectivity Options

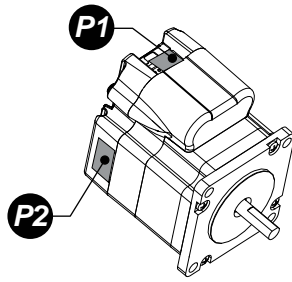

Connector Style Function

P1 12-pin Wire Crimp..... I/O and power

P2 10-pin IDC..... Communications

P1 I/O, Power and Communications

12-pin wire crimp

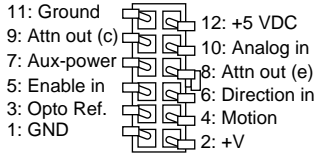

CONNECTOR PRODUCT ALERT! October 2009

Disregard these pin number markings. Use the pin numbering scheme shown above.

The manufacturer of this 12-pin wire crimp connector has begun marking the connector shell, PN 1-794617-2 with pin numbers shown here.

Prototype Development Cable p/n: PD12-1434-FL3

Speed test and development with pre-wired mating connector.

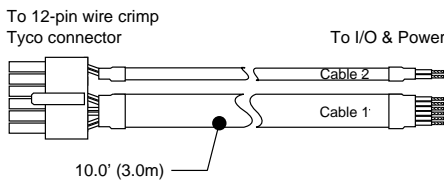

Wire Colors	Function
Gray/White	Analog ground
White/Gray	Analog input
White/Brown	Aux power
Brown/White	+5V output
White/Green	Attn out (c)
Green/White	Attn out (e)
White/Orange	Enable
Orange/White	Direction
White/Blue	Opto Ref
Blue/White	Motion
Black	Power Gnd
Red	+V
Uninsulated	Drain Wire

Mating Connector Kit p/n: CK-03

Use to make your own cables, kit contains 5 mating connector shells for making interface cables. Tyco crimp tool recommended.

Tyco Parts Shell: 1-794617-2
Pins: 794610-1

P3 Encoder

10-pin wire crimp

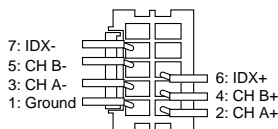

Prototype Development Cable p/n: ED-CABLE-JST10

Function: Encoder Interface

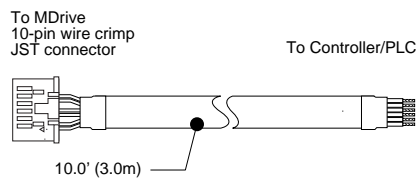

Pair	Wire Colors	Function
1	White/Blue	IDX+
	Blue/White	IDX-
2	White/Orange	CH B+
	Orange/White	CH B-
3	White/Green	CH A+
	Green/White	CH A-
4	White/Brown	Ground
	Brown/White	N/C

Mating Connector Kit p/n: CK-13

Use to make your own cables, kit contains 5 mating connector shells with crimp pins. JST crimp tool recommended.

JST Parts Shell: PADP-10V-1-S
Pins: SPH-001T-P0.5L

P2 Communications — RS-422/485

10-pin wire crimp

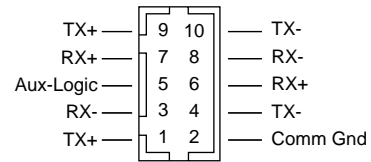

Communications Converter p/n: MD-CC402-001

Electrically isolated in-line USB to RS-422/485 converter pre-wired with mating connector to conveniently program and set configuration parameters.

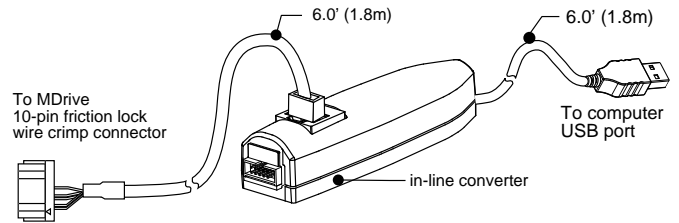

Prototype Development Cable p/n: PD10-1434-FL3

Speed test and development with pre-wired mating connector. Recommended for multi-drop systems, can be used in conjunction with the MD-CC402-001.

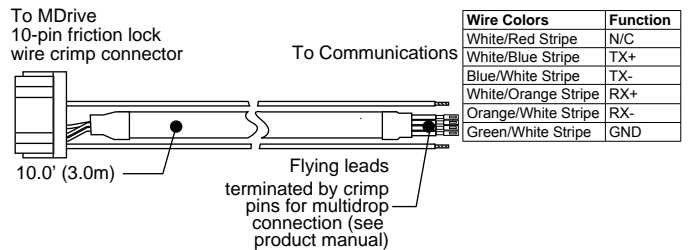

Mating Connector Kit p/n: CK-02

Use to make your own cables, kit contains 5 mating connector shells with crimp pins. Hirose crimp tool recommended.

Hirose Parts: Shell: DF11-10DS-2C
Pins: DF11-2428SC