

# Quick Reference MDrive® AccuStep 23 Motion Control



## Notes and Warnings

Installation, configuration and maintenance must be carried out by qualified technicians only. You must have detailed information to be able to carry out this work. This information can be found in the user manuals.

- Unexpected dangers may be encountered when working with this product!
- Incorrect use may destroy this product and connected components!

The user manuals are not included, but may be obtained from the Internet at: <http://www.imshome.com/downloads/manuals.html>.

## Required for Setup\*

- PC running Microsoft® Windows XP Service Pack 2 or greater.
- IMS Terminal integrated program editor and terminal emulator (available online).
- +12 to +60 VDC unregulated linear or switching power supply.
- RS-422/485 communications interface (recommended: MD-CC402-001 communication converter).

You may also need:

- Power interface to 2-pin wire crimp connector (recommended: PD02-2300-FL3 prototype development cable).
- I/O interface to 14-pin wire crimp connector (recommended: PD14-2334-FL3 prototype development cable).

\* If you purchased your MDrive AccuStep with a QuickStart Kit, you have received all of the connecting cables needed for initial functional setup and system testing.

## Getting Started

All documentation, software and resources are available online at: [http://www.imshome.com/products/mdrive\\_motor\\_driver.html](http://www.imshome.com/products/mdrive_motor_driver.html).

### Connecting Power and I/O

Please refer to the opposite side of this document for connecting details and available connectivity options including prototype development cables and mating connector kits.

### Connecting Communications — RS-422/485

1. Connect RS-422/485 communications converter to MDrive AccuStep and PC.
2. Install the communication converter drivers onto PC (available online).
3. Install and open IMS Terminal.
4. Apply power to the device.
5. Within IMS Terminal, Click into the Terminal Window (shown below).
6. Key in CTRL+C. The sign-on message: "Copyright 2001-2009 by Intelligent Motion Systems, Inc." should appear, verifying that communications is active.

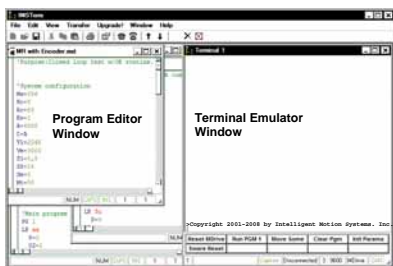

## General Specifications

Electrical Specifications	
Input Voltage (+V) Range*	+12 to +60 VDC
Max Power Supply Current (Per MDrive)*	2 A
Aux-Logic Input Voltage**	+12 to +24 VDC
Aux-Logic Input Current**	194 mA Max

\*Actual Power Supply Current will depend on voltage and load.  
\*\*Used to power logic circuitry in the absence of +V.

Environmental Specifications	
Operating Temperature (non-condensing)	Heat Sink: -40°C to +85°C Motor: -40°C to +100°C

I/O Specifications	
<b>General Purpose I/O - Number and Type</b>	
I/O Points 1-4, 9-12	8 I/O programmable as inputs or outputs (sinking or sourcing)
<b>General Purpose I/O - Electrical</b>	
Inputs	TTL up to +24 VDC
Sinking Outputs	Up to +24 VDC
Sourcing Outputs	+12 to +24 VDC
Output Sink Current	up to 600 mA (One Channel in each I/O Bank)
Logic Threshold (Logic 0)	< 0.8 VDC
Logic Threshold (Logic 1)	> 2.2 VDC
Protection (Sinking)	Over Temp, Short Circuit
Protection (Sourcing)	Transient Over Voltage, Inductive Clamp
<b>Analog Input</b>	
Resolution	10 Bit
Range (Voltage Mode)	0 to +5 VDC, 0 to +10 VDC
Range (Current Mode)	4 to 20 mA, 0 to 20mA
<b>Trip Output/Capture Input</b>	
Logic Threshold	+5V TTL Input, TTL Output (with 2 kΩ Load to Ground)

Communications Specifications	
Protocol	RS-422/RS-485
BAUD Rate	4.8k, 9.6k, 19.2k, 38.4k, 115.2 kbps

Motion Specifications	
<b>Microstep Resolution - Open Loop</b>	
Number of Resolutions	20

Available Microsteps Per Revolution									
200	400	800	1000	1600	2000	3200	5000	6400	10000
12800	20000	25000	25600	40000	50000	51200	36000 <sup>1</sup>	21600 <sup>2</sup>	25400 <sup>3</sup>

1=0.01 deg/μstep    2=1 arc minute/μstep    3=0.001 mm/μstep

Software Specifications	
Program Storage Type/Size	Flash/6384 Bytes
User Program Labels and Variables	192
Party Mode Addresses	62

## Mechanical Specifications

NOTE: For linear actuator products, see manual for screw specifications

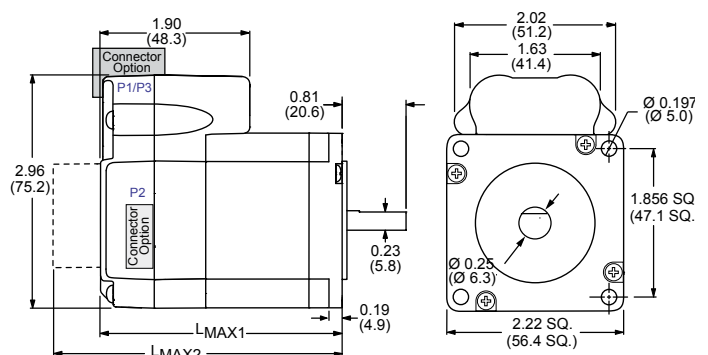

Motor Length	Dimensions in inches (mm)	
	LMAX (Single Shaft or Internal Encoder)	LMAX2 (Control Knob)
Single	2.65 (67.31)	3.36 (85.34)
Double	3.02 (76.71)	3.73 (94.74)
Triple	3.88 (98.55)	4.59 (116.59)
Quad	5.28 (135.15)	5.99 (152.19)

# MDrive AccuStep 23 Motion Control Connectivity Options

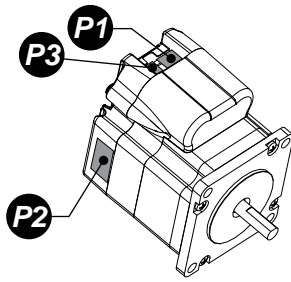

Connector Style                      Function

- P1** 14-pin Wire Crimp..... I/O
- P2** 10-pin Wire Crimp..... Communications
- P3** 2-pin Wire Crimp..... Power

## **P1** I/O

14-pin wire crimp

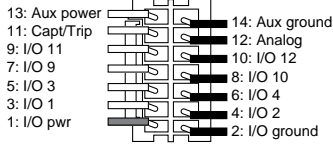

### Prototype Development Cable p/n: PD14-2334-FL3

Speed test and development with pre-wired mating connector.

To MDrive  
14-pin wire crimp  
JST connector

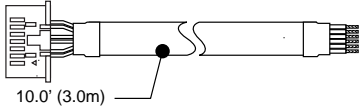

To I/O

Pair	Wire Colors	Function
1	White	Aux Power
	Black	Aux Ground
2	Green	Capt/Trip
	Black	Analog In
3	Blue	I/O11
	Black	I/O12
4	Yellow	I/O9
	Black	I/O10
5	Brown	I/O3
	Black	I/O4
6	Orange	I/O1
	Black	I/O2
7	Red	I/O Power
	Black	I/O Ground

### Mating Connector Kit p/n: CK-09

Use to make your own cables, kit contains 5 mating connector shells with crimp pins. JST crimp tool recommended.

JST Parts                      Shell: PADP-14V-1-S  
Pins: SPH-001T-P0.5L

## **P3** Power

2-pin wire crimp

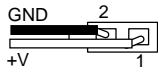

### Prototype Development Cable p/n: PD02-2300-FL3

Function: Power Interface

To MDrive  
2-pin wire crimp

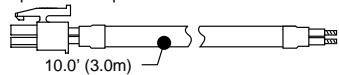

To Power

Wire Colors	Function
Black	Power Ground
Red	+V

### Mating Connector Kit p/n: CK-04

Use to make your own cables, kit contains 5 mating connector shells with crimp pins. Tyco crimp tool recommended.

Tyco Parts                      Shell: 794617-2  
Pins: 794610-1

## **P3** Encoder

10-pin wire crimp

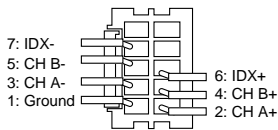

### Prototype Development Cable p/n: ED-CABLE-JST10

Function: Encoder Interface

To MDrive  
10-pin wire crimp  
JST connector

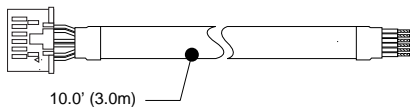

To Controller/PLC

Pair	Wire Colors	Function
1	White/Blue	IDX+
	Blue/White	IDX-
2	White/Orange	CH B+
	Orange/White	CH B-
3	White/Green	CH A+
	Green/White	CH A-
4	White/Brown	Ground
	Brown/White	N/C

### Mating Connector Kit p/n: CK-13

Use to make your own cables, kit contains 5 mating connector shells with crimp pins. JST crimp tool recommended.

JST Parts                      Shell: PADP-10V-1-S  
Pins: SPH-001T-P0.5L

## **P2** Communications — RS-422/485

10-pin wire crimp

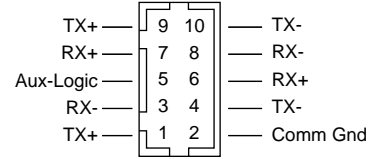

### Communications Converter p/n: MD-CC402-001

Electrically isolated in-line USB to RS-422/485 converter pre-wired with mating connector to conveniently program and set configuration parameters.

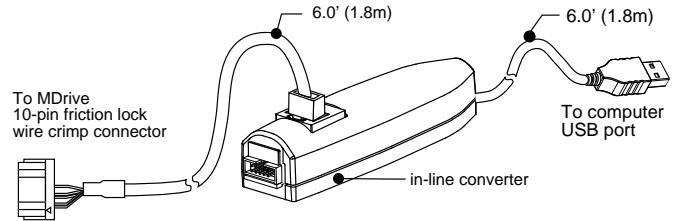

### Prototype Development Cable p/n: PD10-1434-FL3

Speed test and development with pre-wired mating connector. Recommended for multi-drop systems, can be used in conjunction with the MD-CC402-001.

To MDrive  
10-pin friction lock  
wire crimp connector

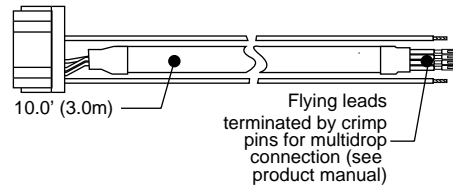

Wire Colors	Function
White/Red Stripe	N/C
White/Blue Stripe	TX+
Blue/White Stripe	TX-
White/Orange Stripe	RX+
Orange/White Stripe	RX-
Green/White Stripe	GND

### Mating Connector Kit p/n: CK-02

Use to make your own cables, kit contains 5 mating connector shells with crimp pins. Hirose crimp tool recommended.

Hirose Parts                      Shell: DF11-10DS-2C  
Pins: DF11-2428SC