

NEMA23 stepper motors

1.8° 2-phase stepper motors



Dimensions — NEMA23

Dimensions in inches (mm)

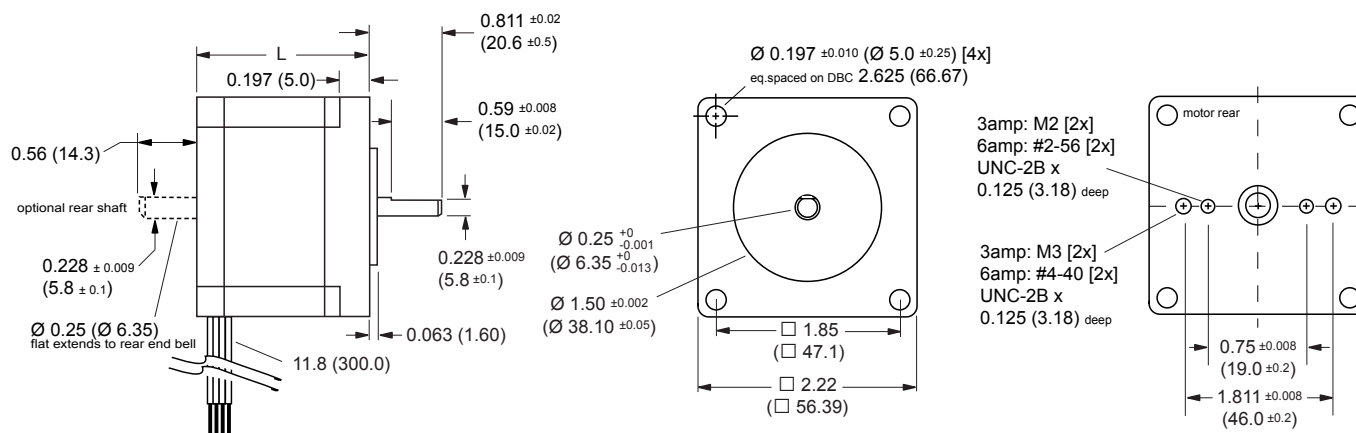

	L		
	2.4 amp motor	3.0 amp motor	6.0 amp motor
M-2218•	1.77 (45)	1.77 (45)	1.75 (44.5)
M-2226•	2.13 (54)	2.13 (54)	2.2 (56)
M-2231•	2.99 (76)	2.99 (76)	3.09 (79)

Ambient conditions

Ambient temperature	°C	-25 ... +40
Max. installation height over m.s.l. without power loss	m	< 1000
Transport and storage temperature	°C	-25 ... +70
Relative humidity	%	15 ... 85, no condensation allowed
Thermal class		130 (B)

Electrical and mechanical data

NEMA23		M-2218-2.4S	M-2222-2.4S	M-2231-2.4S	M-2218-3.0•	M-2222-3.0•	M-2231-3.0•	M-2218-6.0•	M-2222-6.0•	M-2231-6.0•
Stack length		single	double	triple	single	double	triple	single	double	triple
Phase current	amps	2.4	2.4	2.4	3.0	3.0	3.0	6.0	6.0	6.0
Holding torque	oz-in	90	144	239	90	144	239	100	150	257
	N-cm	64	102	169	64	102	169	71	106	181
Rotor inertia	oz-in-sec ²	0.00255	0.00368	0.0065	0.00255	0.00368	0.0065	0.0017	0.00397	0.0068
	kg-cm ²	0.18	0.26	0.46	0.18	0.26	0.46	0.12	0.28	0.48
Phase inductance	mH	2.4	4.0	5.4	1.5	2.6	3.36	0.47	0.73	1.04
Phase resistance	Ω	0.95	1.2	1.5	0.65	0.85	0.95	0.16	0.19	0.23
Weight	oz	16.9	21.2	35.3	16.9	21.2	35.3	16.6	24.7	35.3
	grams	480	600	1000	480	600	1000	470	700	1000

References							
Example:	M	-	2	2	2	2	- 3.0 S
Motor type M = stepper motor	M	-	2	2	2	2	- 3.0 S
Flange size 22 = NEMA23 (57 mm)	M	-	2	2	2	2	- 3.0 S
Motor length 18 = single stack 22 = double stack 31 = triple stack	M	-	2	2	2	2	- 3.0 S
Phase current 2.4 = 2.4 amp (1) 3.0 = 3.0 amp 6.0 = 6.0 amp	M	-	2	2	2	2	- 3.0 S
Shaft S = single shaft D = double shaft (1)							S
Optional encoder (1) Selecting the encoder option replaces the shaft designator in the part number ES = single-end optical encoder ED = differential optical encoder 100 = line count 200 = line count 250 = line count 400 = line count 500 = line count 1000 = line count							ES100

(1) Double shaft and encoder option are unavailable with 2.4amp NEMA23 motors.

Dimensions in inches (mm)

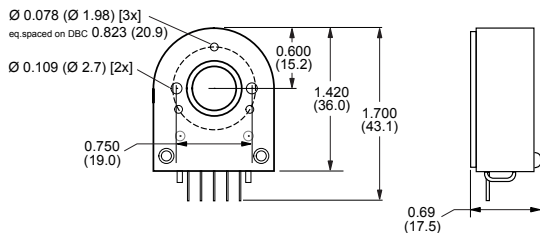

Encoders		
Optical encoder	ES* (single-end)	ED* (differential)
Number of signals	3	5
Line counts (1)	100, 200, 250, 400, 500 or 1000	100, 200, 250, 400, 500 or 1000
Mating cable part #	ES-CABLE-2	ED-CABLE-6
Mating cable lengths feet (m)	1.0 (0.3)	6.0 (1.8)

(1) All encoders have an index mark, except the 1000 line count version.

NEMA23 stepper motors

1.8° 2-phase

Speed-torque curves

M-2218-2.4S

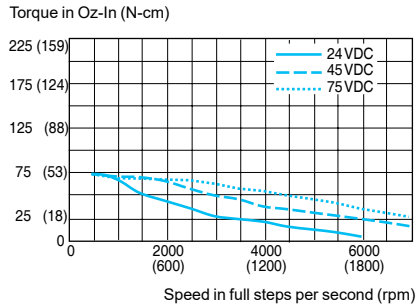

M-2222-2.4S

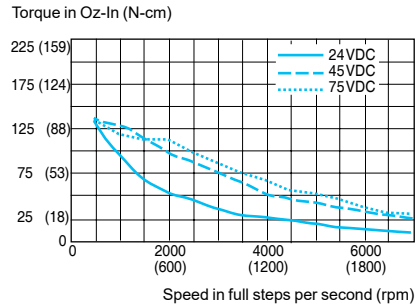

M-2231-2.4S

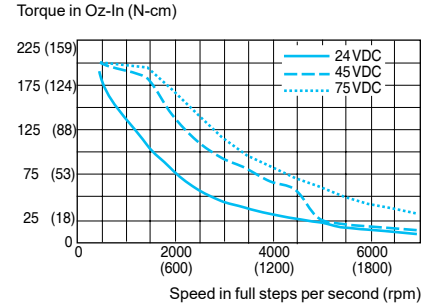

M-2218-3.0•

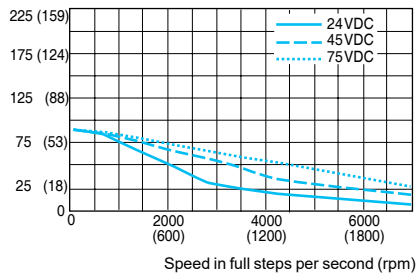

M-2222-3.0•

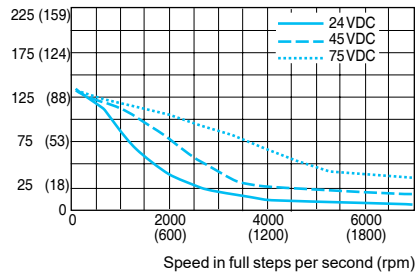

M-2231-3.0•

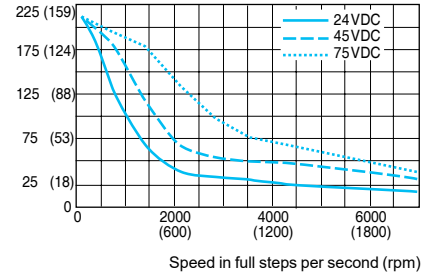

M-2218-6.0•

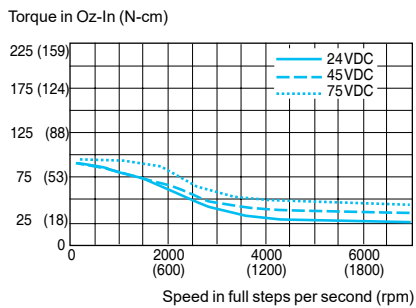

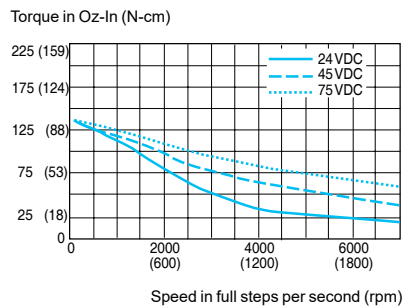

M-2222-6.0•

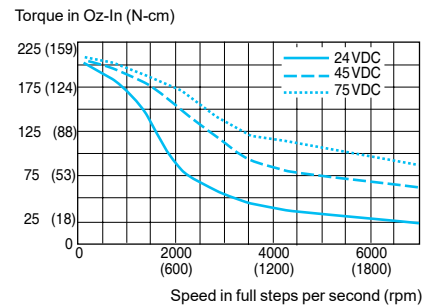

M-2231-6.0•



Complete product offer

2-phase stepper motors		M-11•	M-14•	M-17•	M-22•	M-34•
						
Size	NEMA	11	14	17	23	34
Holding torque	oz-in	13 ... 24	10	32 ... 75	90 ... 239	408 ... 1090
	N-cm	9 ... 17	7	23 ... 53	64 ... 169	288 ... 770
Number of full steps per revolution		200				
Step angle α		1.8°				
Motor connection		pluggable connector		4 flying leads		

Motor types

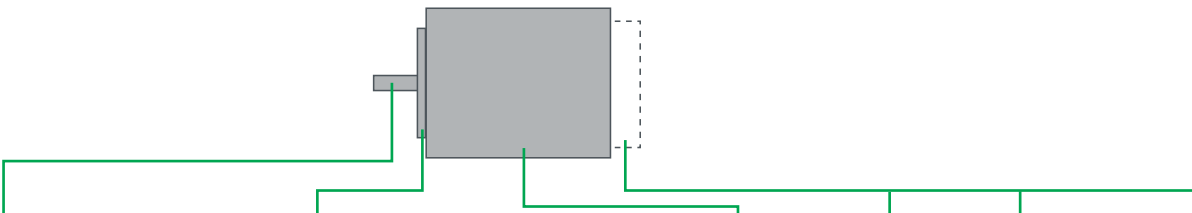

Shaft version	Centering collar		Flange size		Lengths without shaft		Winding	Motor connection	Optional rear shaft (1)	Optional encoder		
	inches	mm	inches	mm	inches	mm						
M-11•												
Round shaft with single flat feature	Ø 0.197	Ø 5.0	Ø 0.866	Ø 22	0.65	16.5	1.22 1.57 2.01	31 40 51	2-phase full coil for bi-polar operation	pluggable connector	Round shaft	1000-line differential
M-14•												
Round shaft with single flat feature	Ø 0.197	Ø 5.0	Ø 0.866	Ø 22	1.39	35.3	1.02	26	2-phase full coil for bi-polar operation	4 flying leads	Round shaft	Single-end or differential
M-17•												
Round shaft with single flat feature	Ø 0.197	Ø 5.0	Ø 0.866	Ø 22	1.67	42.3	1.34 1.57 1.89	34 40 48	2-phase full coil for bi-polar operation	4 flying leads	Flat feature extending to rear end bell	Single-end or differential
M-22•												
Round shaft with single flat feature	Ø 0.25	Ø 6.35	Ø 1.50	Ø 38	2.22	56.4	1.77 2.13 2.99	45 54 76	2-phase full coil for bi-polar operation	4 flying leads	Flat feature extending to rear end bell (2)	Single-end or differential
M-34•												
Round shaft with single flat feature	Ø 0.554	Ø 14.0	Ø 2.874	Ø 73	3.386	86.0	2.48 3.15 4.72	63 80 120	2-phase full coil for bi-polar operation	4 flying leads	Flat feature on round shaft	Single-end or differential

(1) Optional rear shaft available except for NEMA23 2.4amp motors.

(2) Optional rear shaft on NEMA23 6.0amp motors is round without a flat feature.

Schneider Electric Motion USA

370 North Main Street
Marlborough, CT 06447 – U.S.A.

motion.schneider-electric.com