

MDrive® Plus

MDI•34 programmable Motion Control

Product overview

MDrive® Plus Motion Control products integrate 1.8° 2-phase stepper motor, fully programmable motion controller, drive electronics and optional encoder. Products with encoders include stall detection, position maintenance, and find index mark.

Programming for these stand-alone motion control solutions is via RS-422/485 interface with MCode software using simple 1 to 2 character instructions.

Application areas

MDrive Plus products deliver reliable performance for new and existing motion control applications. Satisfying the requirements for a wide range of machine builders.

Simplify your machine design and reduce cabinet size by replacing multiple components with a single compact integrated motor. Fewer individual system components eliminates multiple potential

failure points, and lowers risk of electrical noise by eliminating cabling between motor and drive.

These compact, powerful and cost effective motion control solutions deliver exceptional smoothness and performance that can reduce system cost, design and assembly time for a large range of 2-phase stepper motor applications.

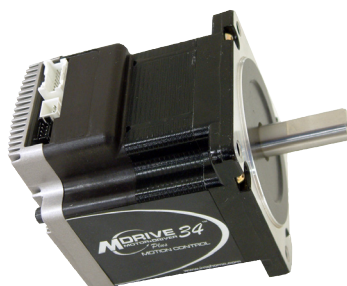

MDI•34 MDrivePlus programmable Motion Control products: integrated NEMA34 motor and controls, IP20-rated

General features

Compact integrated microstepping drive, programmable motion controller and NEMA34 1.8° 2-phase stepper motor	
Advanced current control for exceptional performance and smoothness	
+12 to +75 VDC single supply	
20 microstep resolutions up to 51,200 steps per rev including: Degrees, Metric, Arc Minutes	
Auxiliary logic power supply input	
0 to 5 MHz step clock rate selectable in 0.59 Hz increments	
Up to 8 I/O lines	
One 10 bit selectable analog input	
Communication	RS-422/485
Protection	IP20 rating
	Thermal temp warning, over voltage/current
Programmable	Motor run/hold current
Available options	Motor stack lengths
	Connector options
	Encoders
	Rear control knob for manual positioning
Graphical user interface provided for quick and easy parameter setup	

MDrive Plus

MDI•34 programmable Motion Control

Specifications

Communication	Protocol type	RS-422/485	4.8 to 115.2 kbps baud rate	
Input power	Voltage	VDC	+12...+75	
	Current maximum (1)	Amp	4.0	
Motor	Frame size	NEMA	34	
		inches	3.4	
		mm	85	
	Holding torque	oz-in	408...1090	
		N-cm	288 ... 770	
Length	stack sizes	1, 2 & 3		
Thermal	Operating temp non-condensing	Heat sink maximum	75°C	
		Motor maximum	90°C	
Protection	Type	IP rating	IP20	
		Temp warning	Thermal, over voltage/current	
		I/O warnings	Over temp, short circuit, transient, over voltage, inductive clamp	
Auxiliary logic input	Voltage range		+12 to +24 VDC When input voltage is removed, maintains power only to control and feedback circuits.	
Analog input	Resolution		10 bit	
	Voltage range		0 to +5 VDC, 0 to +10 VDC, 0-20 mA, 4-20 mA	
General purpose I/O	Output sinking current		Up to 600 mA	
	Plus products	Number	4	
		Type		Sourcing or sinking inputs, or sinking outputs
		Logic range		Inputs and outputs tolerant to +24 VDC, inputs TTL level compatible
	Plus ² products	Number		8 or 4 (2)
		Type		Sourcing or sinking outputs/inputs
Logic range			Sourcing outputs +12 to +24 VDC, inputs and sinking outputs tolerant to +24 VDC, inputs TTL level compatible	
Motion	Open loop configuration	Number of settings	20	
		Steps per revolution	200, 400, 800, 1000, 1600, 2000, 3200, 5000, 6400, 10000, 12800, 20000, 25000, 25600, 40000, 50000, 51200, 36000 (0.01 deg/μstep), 21600 (1 arc minute/μstep), 25400 (0.001mm/μstep)	
	Counters	Type		Position, encoder / 32 bit
		Edge rate maximum		5 MHz
	Velocity	Range		+/- 5,000,000 steps per second
		Resolution		0.5961 steps per second
	Accel/Decel	Range		1.5 to 10 ⁹ steps per second ²
		Resolution		90.9 steps per second ²
	Position feedback	Optional		Encoder required
	Expanded motion Plus ² products only	Electronic gearing external clock in (3)	Range	0.001 to 2.000
			Resolution	32 bit
Threshold			TTL	
High speed I/O		Position capture		Input filter range 50 nS to 12.9 μS (10 MHz to 38.8 kHz)
			Resolution 32 bit	
	Trip output		Speed 150 nS Resolution 32 bit Threshold TTL	
Position feedback	Optional		Remote encoder interface required	
Software	Program storage	Type/size	Flash/6384 bytes	
	User registers		Four 32 bit	
	User program labels & variables		192	
	Math functions		+, -, x, ÷, >, <, <=, >=, AND, OR, XOR, NOT	
	Branch functions		Branch and Call	
	General purpose I/O functions	Inputs		home, limit plus, limit minus, go, stop, pause, jog plus, jog minus, general purpose moving, fault, stall, velocity change, general purpose
		Outputs		
	Trip functions			Trip on input, trip on position, trip on time, trip capture, trip on relative position
	Party mode addresses			62
	Encoder functions			Stall detection, position maintenance, find index

(1) Actual power supply current will depend on voltage and load.

(2) I/O is reduced from 8 to 4 for products with remote encoder option.

(3) Adjusting the microstep resolution can increase the range.

MDrive Plus

MDI•34 programmable Motion Control

Dimensions

MDI•34 NEMA34 motor, IP20-rated

inches (mm)

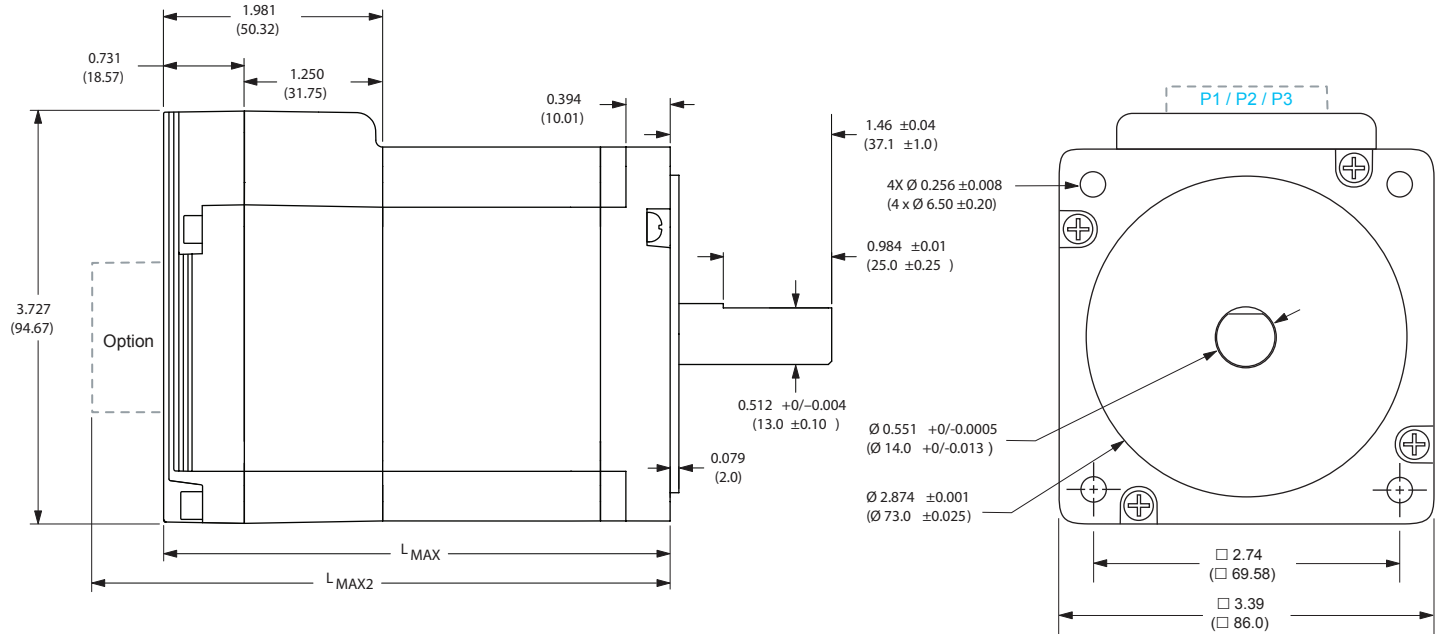

Motor stack length	Lmax	Lmax2
Single	3.81 (96.77)	4.52 (114.81)
Double	4.60 (116.84)	5.31 (134.87)
Triple	6.17 (156.72)	6.88 (174.75)

Connector options

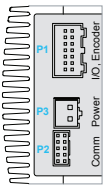

Pluggable interface version:
14-pin* and 2-pin locking wire crimp and 10-pin friction lock wire crimp connectors

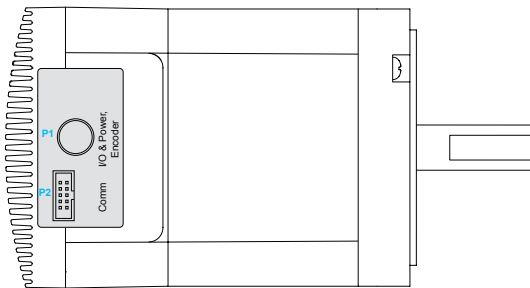

Flying leads interface version:
12* (305mm) flying leads with 10-pin non-locking IDC connector

Lmax2 option



control knob

* 14-pin replaced by 20-pin locking wire crimp connector when optional remote encoder is included

MDrive Plus

MDI•34 programmable Motion Control

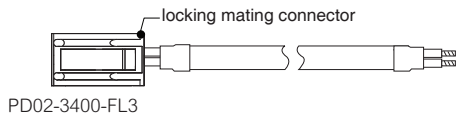
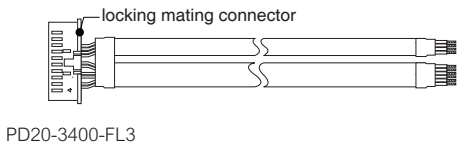
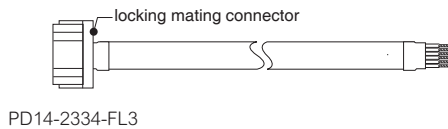
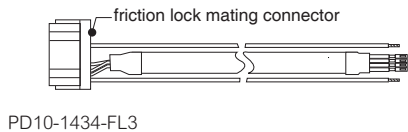
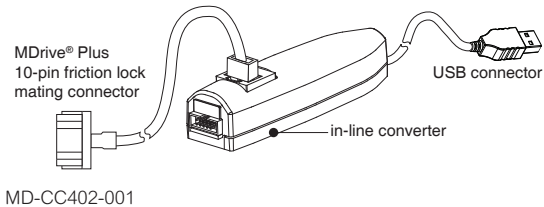
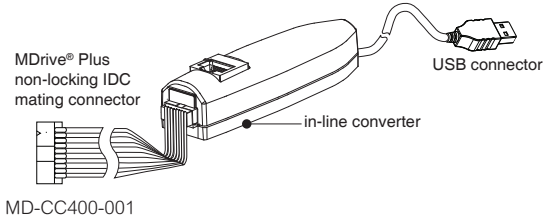

Accessories

description	length feet (m)	part number
-------------	-----------------	-------------

QuickStart Kit

For rapid design verification, all-inclusive QuickStart Kits includes prototype development cables and a communication converter for MDrivePlus initial functional setup and system testing.

For all MDrive34 programmable Motion Control products	—	add "K" to part number
---	---	------------------------

Communication converter

Electrically isolated, in-line converter pre-wired with mating connector to conveniently set/program communication parameters for a single MDrive Plus via a PC's USB port.

Mates to 10-pin non-locking IDC connector	12.0 (3.6)	MD-CC400-001
Mates to 10-pin friction lock wire crimp connector	12.0 (3.6)	MD-CC402-001

Prototype development cable

Speed test/development with pre-wired mating connector with other cable end open.

Mates to 10-pin locking wire crimp connector for I/O and remote encoder option	10.0 (3.0)	PD10-1434-FL3
Mates to 14-pin locking wire crimp connector for I/O and remote encoder option	10.0 (3.0)	PD14-2334-FL3
Mates to 20-pin locking wire crimp connector for I/O and remote encoder option	10.0 (3.0)	PD20-3400-FL3
Mates to 2-pin locking wire crimp connector for power	10.0 (3.0)	PD02-3400-FL3

Mating connector kits

Connectors for assembly of cables, cable material not supplied. Sold in lots of 5. Manufacturer's crimp tool recommended for crimp connectors.

10-pin friction lock wire crimp connector for communication	—	CK-02
14-pin locking wire crimp connector for I/O and remote encoder option	—	CK-09
20-pin locking wire crimp connector for I/O and remote encoder option	—	CK-11
2-pin locking wire crimp connector for power	—	CK-05
10-pin non-locking IDC connector for communication	—	CK-01

Drive protection module

Limits surge current and voltage to a safe level when DC input power is switched on-and-off to an MDrive Plus.

For all MDrive34 programmable Motion Control products	—	DPM75
---	---	-------

MDrive Plus

MDI•34 programmable Motion Control

MDrive® 34 Plus IP20 flying leads interface

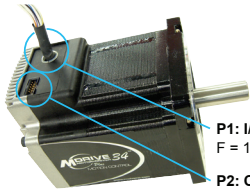

P1: I/O & Power
F = 12" flying leads

P2: Communication
D = RS-422/485 with 10-pin IDC non-locking connector
L = RS-422/485 with 10-pin friction lock wire crimp connector

MDrive® 34 Plus² IP20 pluggable interface

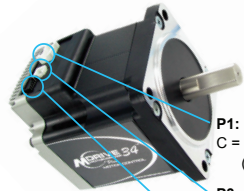

P1: I/O, and optional remote encoder
C = 14-pin locking wire crimp connector (20-pin with remote encoder option)

P3: Power
2-pin locking wire crimp connector

P2: Communication
L = RS-422/485 with 10-pin friction lock wire crimp connector

Part numbers,

IP20-rated products

example part number	K	M	D	I	1	F	R	D	3	4	A	7	-N
QuickStart Kit K = kit option, omit from part number if unwanted	K	M	D	I	1	F	R	D	3	4	A	7	-N
MDrivePlus version MDI = Intelligent — programmable Motion Control	K	M	D	I	1	F	R	D	3	4	A	7	-N
Input 1 = Plus version with standard features 3 = Plus ² version with expanded features	K	M	D	I	1	F	R	D	3	4	A	7	-N
P1 connector F = flying leads (1) C = wire crimp (2)	K	M	D	I	1	F	R	D	3	4	A	7	-N
Communication type R = RS-422/485	K	M	D	I	1	F	R	D	3	4	A	7	-N
P2 connector D = IDC (1) L = wire crimp	K	M	D	I	1	F	R	D	3	4	A	7	-N
Motor size 34 = NEMA 34 3.4" / 85mm	K	M	D	I	1	F	R	D	3	4	A	7	-N
Motor length A = single stack B = double stack C = triple stack	K	M	D	I	1	F	R	D	3	4	A	7	-N
Drive voltage 7 = +12 to +75 VDC	K	M	D	I	1	F	R	D	3	4	A	7	-N
Options — omit from part number if unwanted													-N
-N = rear control knob for manual positioning													
-EQ = internal 512-line optical encoder w/ index mark													
-EE (2) = remote differential encoder interface; encoder not supplied													

(1) Only available with Plus products.
(2) Only available with Plus² products.

MDrive Plus

MDI•34 programmable Motion Control

Motor performance

MD•34 NEMA 34 motor specifications	Motor	Stack length	Single	Double	Triple
			Holding torque	oz-in	408
	N-cm	288	405	770	
Detent torque	oz-in	10.9	14.16	19.83	
	N-cm	7.7	10.0	14.0	
Rotor inertia	oz-in-sec ²	0.01275	0.01924	0.03849	
	kg-cm ²	0.90	1.35	2.70	
Weight (motor+driver)	lb	4.1	5.5	8.8	
	kg	1.9	2.5	4.0	

MD•34 NEMA 34 speed torque (1)

Single stack length

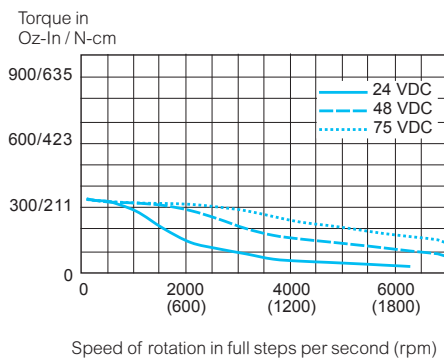

Double stack length

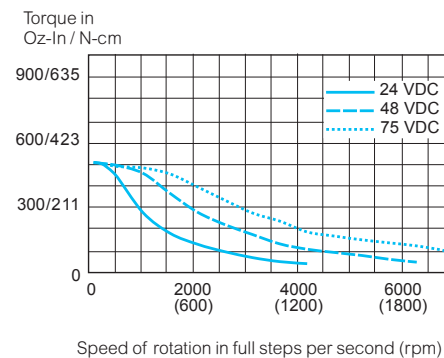

Triple stack length

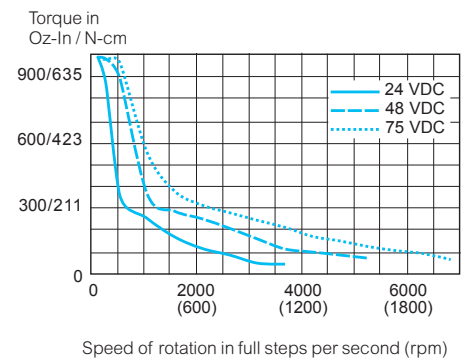

(1) Test conditions: 100% current with damper simulating load.