

MDrive® Linear Actuator

MLM•17 Step/direction input

Product overview

MDrive® Linear Actuators are compact linear motion systems. External or non-captive shaft linear mechanicals are integrated with stepper motor and electronics for reliable, repeatable motion. Customization is available for volume opportunities.

Step/direction input products integrate 1.8° 2-phase stepper motor linear actuator, drive electronics and optional encoder. Step/direction signals of a master controller, e.g. a motion controller, or A/B signals of an encoder are converted directly into motion. Settings may be changed on-the-fly or downloaded and stored in nonvolatile memory using provided software.

MDrive product's precision rolled lead screws are manufactured from premium grade stainless steel with optional Teflon® coating. Designed specifically for motion control applications, our high quality screws deliver long life and quiet operation.

Simplify machine design and reduce assembly time by replacing multiple components with a single compact integrated motor. Fewer individual system components eliminates multiple potential failure points, and lowers risk of electrical noise by eliminating cabling between motor and drive.



MDrive Linear Actuator MLM•17 Step/direction products: integrated NEMA17 motor, controls and mechanicals, non-captive and external shaft styles, IP20-rated

Specifications

Communication	Protocol type		SPI
Input power	Voltage	VDC	+12 ... +48
	Current maximum (1)	Amp	2.0
Motor	Frame size	NEMA	17
		inches	1.7
		mm	42
	Length	stack size	single
Maximum thrust (2)	Non-captive shaft	lbs	50
		kg	22
	External shaft with general purpose nut	lbs	25
		kg	11
	External shaft with anti-backlash nut	lbs	5
		kg	2
Maximum repeatability	General purpose	inch	0.005
		mm	0.127
	Anti-backlash (3)	inch	0.0005
		mm	0.0127
Thermal	Operating temp non-condensing	Heat sink maximum	85°C
		Motor maximum	100°C
Protection	Type	IP rating	IP20
Motion	Microstep resolution	Number of settings	20
		Steps per revolution	200, 400, 800, 1000, 1600, 2000, 3200, 5000, 6400, 10000, 12800, 20000, 25000, 25600, 40000, 50000, 51200, 36000 (0.01 deg/μstep), 21600 (1 arc minute/μstep), 25400 (0.001mm/μstep)

(1) Actual power supply current will depend on voltage and load.

(2) Performance data for maximum force/load is based on a static load and will vary with a dynamic load.

(3) Only applicable for External shaft linear actuator with anti-backlash nut.

See User Manual for complete details: www.motion.schneider-electric.com/manuals.html

MDrive Linear Actuator

MLM•17 Step/direction input

Screws (1)

Screw lengths (2)	minimum	inches	3.0	
		mm	77.5	
	maximum	inches	18.0	
		mm	455.0	
Load limits (3)	non-captive shaft	lbs	50	
		kg	22	
	external shaft w/ general purpose nut	lbs	25	
		kg	11	
	external shaft w/ anti-backlash nut	lbs	5	
		kg	2	
End options	threaded	metric	M4 x 0.7 mm thread to within 0.03"/0.76 mm of shoulder	
		UNC	#8-32 UNC-2A thread to within 0.03"/0.76 mm of shoulder	
	smooth	inches	Ø 0.1967 ±0.001	
		mm	Ø 5 ±0.003	
	none	-	-	
	Lead / pitch	screw A	travel	per rev
inches			0.250	0.00125
		mm	6.350	0.0317
screw B		inches	0.125	0.00063
		mm	3.175	0.0158
screw C		inches	0.063	0.00031
		mm	1.588	0.0079

(1) Stainless steel rolled screws are corrosion resistant and non-magnetic, with Teflon coating available.

(2) Standard 0.1" / 2.5mm screw length increments are available.

(3) Performance data for maximum force/load is based on a static load and will vary with a dynamic load.

screw dimensions

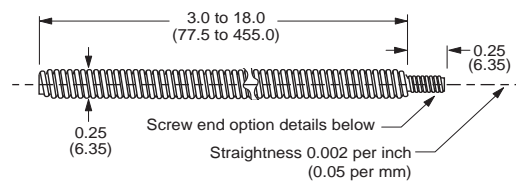

end options

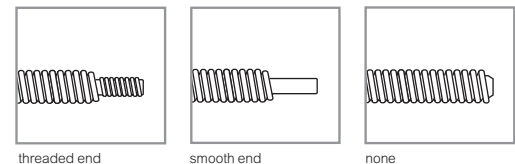

Nuts (4)

			general purpose nuts	anti-backlash nuts
Dimensions	A	inches	0.50	0.50
		mm	12.7	12.7
	B	inches max	0.75	0.9
		mm max	19.1	22.86
	D	inches	1.0	1.0
		mm	25.4	25.4
	E	inches	0.14	0.14
		mm	3.6	3.6
	F	inches	0.15	0.18
		mm	3.81	4.57
BCD	inches	0.75	0.75	
	mm	19.1	19.1	
Load limit	lbs		25	5
	kg		11	2
Drag torque			free wheeling	< 1.0 oz-in < 0.7 N-cm

(4) External shaft MDrive Linear Actuators employ a nut which moves axially along the threaded shaft as the screw rotates. Two nut styles are available: general purpose and anti-backlash. While anti-backlash nuts provide higher accuracy and low drag torque, general purpose nuts are rated for higher load limits.

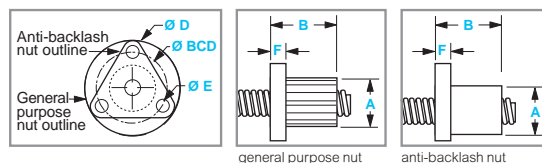

MDrive Linear Actuator

MLM•17 Step/direction input

Dimensions

inches (mm)

MDrive body

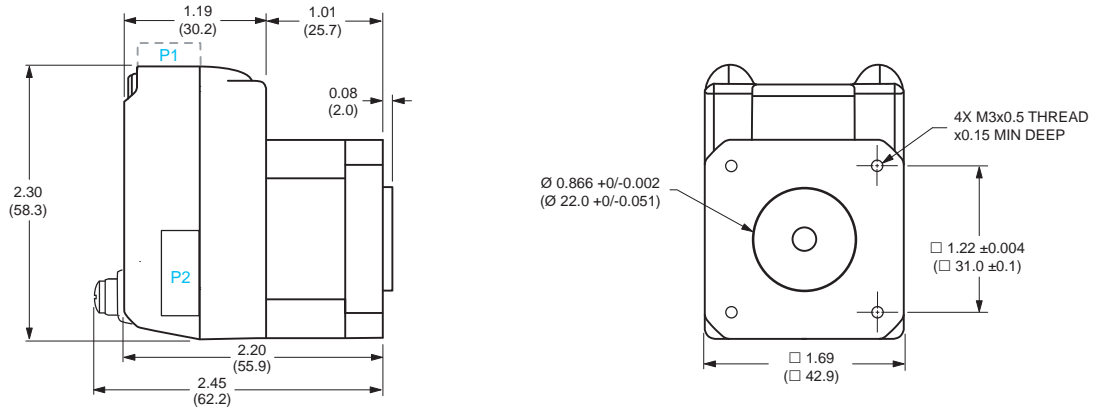

external shaft

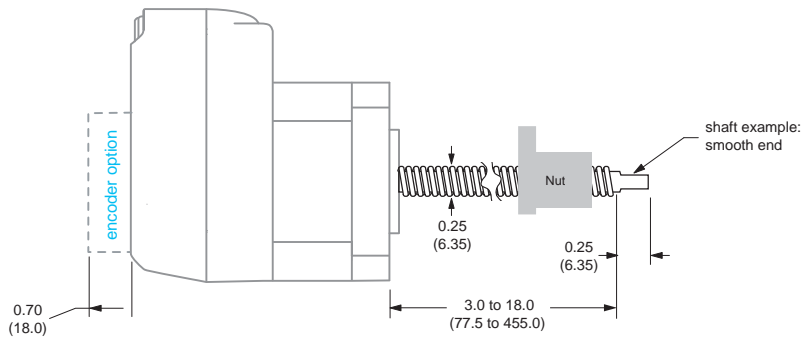

non-captive shaft

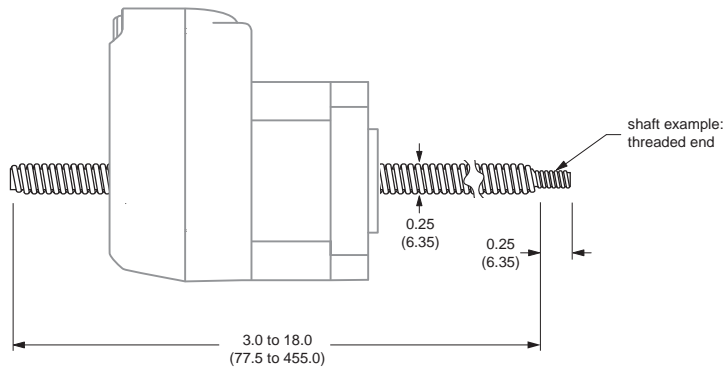

P1 connector options

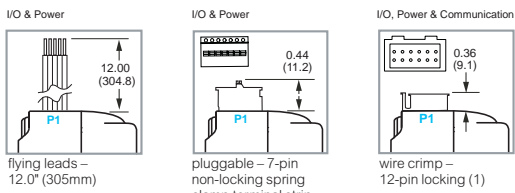

P2 connector options

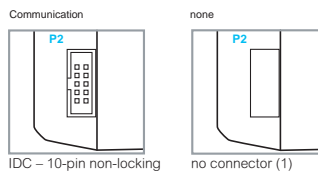

Encoder options

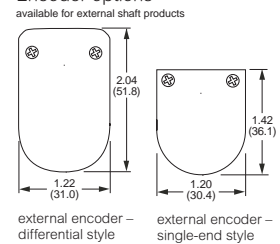

(1) When P1 is a 12-pin connector there is no P2 connector

MDrive Plus

MLM•17 Step/direction input

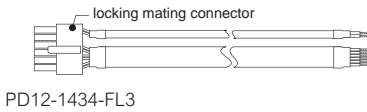
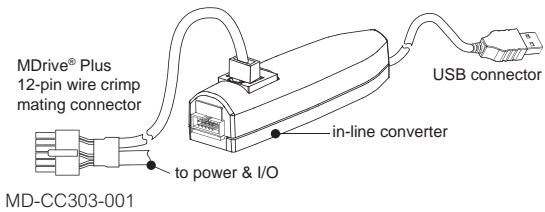
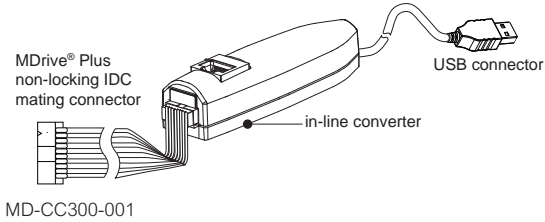

Accessories

description	length feet (m)	part number
-------------	-----------------	-------------

QuickStart Kit

For rapid design verification, all-inclusive QuickStart Kits includes prototype development cables and a communication converter for MDrivePlus initial functional setup and system testing.

For all MLM•17 step/direction input products	—	add "K" to part number
--	---	------------------------

Communication converter

Electrically isolated, in-line converter pre-wired with mating connector to conveniently set/program communication parameters for a single MDrive Plus via a PC's USB port.

Mates to 10-pin non-locking IDC connector	12.0 (3.6)	MD-CC300-001
Mates to 12-pin locking wire crimp connector	12.0 (3.6)	MD-CC303-001

Prototype development cable

Speed test/development with pre-wired mating connector with other cable end open.

Mates to 12-pin locking wire crimp connector for I/O, communication and power	10.0 (3.0)	PD12-1434-FL3
---	------------	---------------

Encoder cables

Pre-wired mating connector with other cable end open.

For external single-end optical encoder with non-locking connector	1.0 (0.3)	ES-CABLE-2
For external differential optical encoder with locking connector	6.0 (1.8)	ED-CABLE-6

Mating connector kits

Connectors for assembly of cables, cable material not supplied. Sold in lots of 5. Manufacturer's crimp tool recommended for crimp connectors.

10-pin non-locking IDC connector for communication	—	CK-01
12-pin locking wire crimp connector for I/O, communication and power	—	CK-03

Drive protection module

Limits surge current and voltage to a safe level when DC input power is switched on-and-off to MDrive product.

For all MDrivePlus linear actuator products	—	DPM75
---	---	-------

MDrive Plus

MLM•17 Step/direction input

MDrive® 17 Plus IP20



- P1: I/O & Power**
 F = 12" flying leads
 P = non-locking spring clamp terminal strip
 C = 12-pin locking wire crimp (includes I/O, Power & Comm)
- P2: Communication**
 D = SPI with 10-pin IDC non-locking connector
 Z = None. Used with 12-pin locking wire crimp in position P1, which includes communication.

Part numbers

IP20-rated products

example part number	K M L M 1 F S D 1 7 A 4 -E1 -●																														
QuickStart Kit K = kit option, omit from part number if unwanted	K M L M 1 F S D 1 7 A 4 -E1 -●																														
MDrive Linear Actuator version MLM = Step/direction input	K M L M 1 F S D 1 7 A 4 -E1 -●																														
Input 1 = Plus version with universal input 5 = Plus version with differential CW/CCW input	K M L M 1 F S D 1 7 A 4 -E1 -●																														
P1 connector F = flying leads P = pluggable C = wire crimp (1)	K M L M 1 F S D 1 7 A 4 -E1 -●																														
Communication type S = SPI	K M L M 1 F S D 1 7 A 4 -E1 -●																														
P2 connector D = IDC Z = none (1)	K M L M 1 F S D 1 7 A 4 -E1 -●																														
Motor size 17 = NEMA 17 1.7" / 42mm	K M L M 1 F S D 1 7 A 4 -E1 -●																														
Motor length A = single stack	K M L M 1 F S D 1 7 A 4 -E1 -●																														
Drive voltage 4 = +12 to +48 VDC	K M L M 1 F S D 1 7 A 4 -E1 -●																														
Options — omit from part number if unwanted -E_ = externally-mounted optical encoder w/ index mark	-E1 -●																														
	<table border="1"> <tr> <td>line count</td> <td>100</td> <td>200</td> <td>250</td> <td>256</td> <td>400</td> <td>500</td> <td>512</td> <td>1000</td> <td>1024</td> </tr> <tr> <td>single-end part #</td> <td>E1</td> <td>E2</td> <td>E3</td> <td>EP</td> <td>E4</td> <td>E5</td> <td>EQ</td> <td>E6</td> <td>ER</td> </tr> <tr> <td>differential part #</td> <td>EAL</td> <td>EBL</td> <td>ECL</td> <td>EWL</td> <td>EDL</td> <td>EHL</td> <td>EXL</td> <td>EJL</td> <td>EYL</td> </tr> </table>	line count	100	200	250	256	400	500	512	1000	1024	single-end part #	E1	E2	E3	EP	E4	E5	EQ	E6	ER	differential part #	EAL	EBL	ECL	EWL	EDL	EHL	EXL	EJL	EYL
line count	100	200	250	256	400	500	512	1000	1024																						
single-end part #	E1	E2	E3	EP	E4	E5	EQ	E6	ER																						
differential part #	EAL	EBL	ECL	EWL	EDL	EHL	EXL	EJL	EYL																						

Linear actuator specifications

Complete the part number from the table below

(1) P2 is Z=none with P1 wire crimp connector.

continued

example part number — linear actuator specifications	-L A 1 M 0 6 0 Z T
Linear actuator -L	-L A 1 M 0 6 0 Z T
Screw lead / pitch by travel per rev A = 0.250" / 6.35mm B = 0.125" / 3.175mm C = 0.063" / 1.588mm	-L A 1 M 0 6 0 Z T
Shaft style 1 = non-captive (2) 3 = external (3)	-L A 1 M 0 6 0 Z T
Screw end finish M = metric threaded U = UNC threaded S = smooth Z = none	-L A 1 M 0 6 0 Z T
Screw length (4) 030 = minimum 3.0" / 77.5mm 180 = maximum 18.0" / 455.0mm	-L A 1 M 0 6 0 Z T
Nut Z = none — for non-captive shaft products G = general purpose — for external shaft products A = anti-backlash — for external shaft products	-L A 1 M 0 6 0 Z T
Coating T = Teflon® Z = none	-L A 1 M 0 6 0 Z T

- (2) Unsupported loads and side loading are not recommended.
 (3) Loads must be supported. Side loading is not recommended.
 (4) Screw lengths specified in 0.1" / 2.5mm increments.



MDrive Plus

MLM•17 Step/direction input

Motor performance

ML•17 NEMA 17 motor specifications		Motor	Stack length	Single
Holding torque			oz-in	29
			N-cm	20
Rotor inertia			oz-in-sec ²	0.0005
			kg-cm ²	0.034
Weight without screw			oz	9.6
			g	272.2
Maximum screw misalignment			°	±1
Maximum thrust (1)	Non-captive shaft		lbs	50
			kg	22
	External shaft with general purpose nut		lbs	25
			kg	11
	External shaft with anti-backlash nut		lbs	5
			kg	2
Maximum repeatability	General purpose		inch	0.005
			mm	0.127
	Anti-backlash (2)		inch	0.0005
			mm	0.0127

(1) Performance data for maximum force/load is based on a static load and will vary with a dynamic load.
 (2) Only applicable for External shaft linear actuator with anti-backlash nut.

ML•17 NEMA 17 speed force

12 VDC

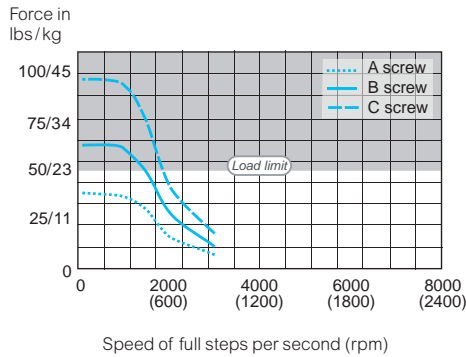

24 VDC

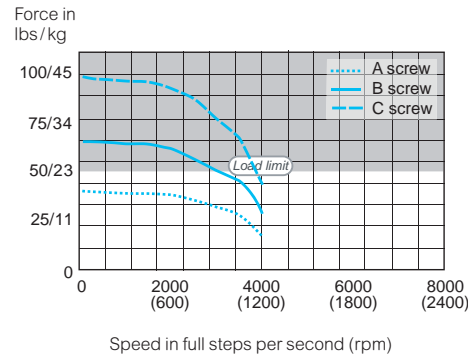

48 VDC

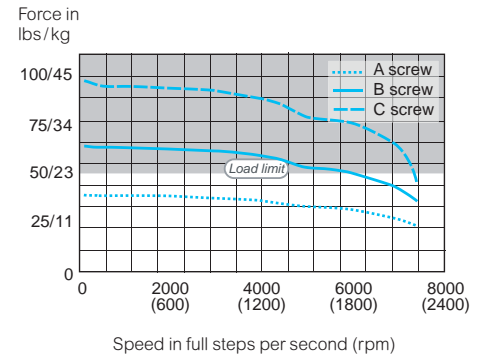

Test conditions: maximum force/load is based on a static load. This will vary with a dynamic load.

Load limits – non-captive shaft: 50lbs/22kg
 – external shaft: determined by selected nut